

SST APPROVAL SHEET

Customer: _____

Customer P/N.: _____

SST P/N.: 254G3-GP

Description: 2.54mm(.100")pitch wire to board Terminal type

Approved No.: _____

Date: _____

Manufacturer's specification

Designed By:	Checked By:	Acknowledged By:
Simmon Chang	May Yang	Tony Chou

Customer Signature

Inspected By:	Checked By:	Approved By:

SOUTH SEA TERMINAL CO.,LTD.

Headquarter: 6f,No.179,Sec.1,ShinTai Wu Rd.Hsi Tzih City,Taipei County,Taiwan R.O.C.

Tel:+886-2-2641-1098 Fax:+886-2-2642-8853 E-mail:sstasia@sstasia.com.tw

Web site [http// www.sstasia.com.tw](http://www.sstasia.com.tw)

Cable-Shen Zhen : B1-B2 Shang Tang Industry District,Zhong-Huan Nan Rd,LongHua Town,Bao'An County,Shen Zhen City,Guangdong Province,China(518131)

Tooling-China : No.4 Industry District,Xin Ye Rd.,Xiagang Village Changan Town, Dongguan,Guangdong Province,China

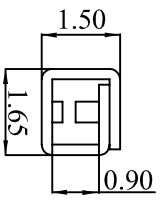
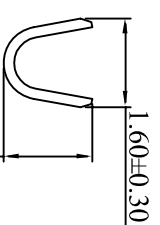
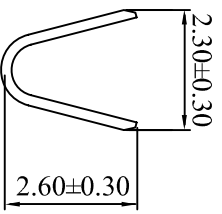
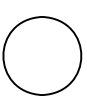
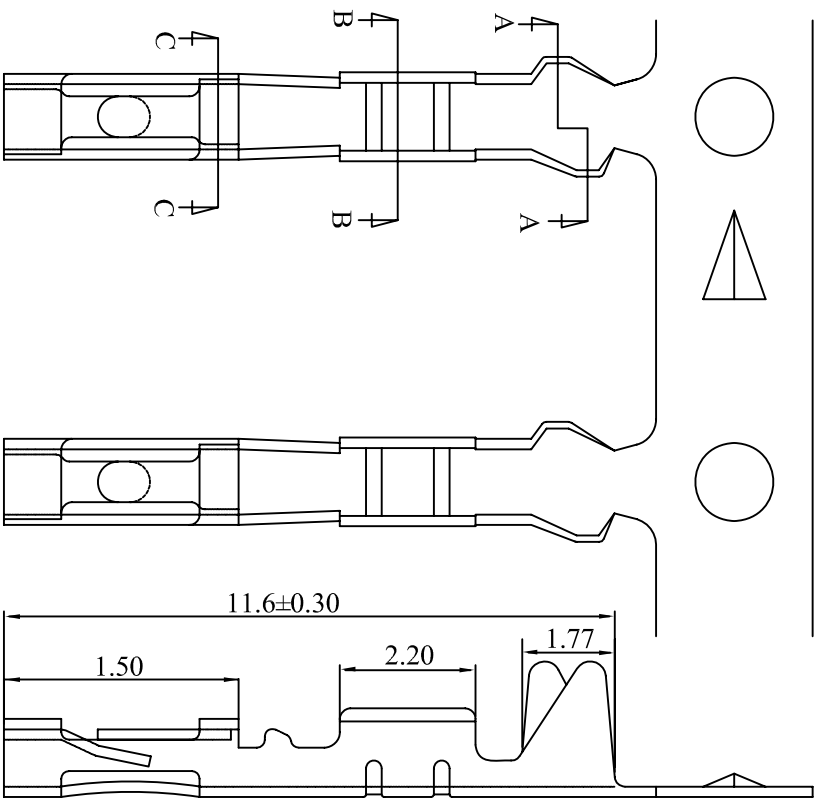

Terminal

- Part No. : 254G3-GP
- Applicable Wires : AWG# 22 - 28
- Material : Brass
- Finish : Gold plated/ gold flash, Tin plated
- Thickness : 0.20mm
- Q'ty : 10000pcs./Reel
- Use in 254G3-1HXX,254G3-2HXX Housing

Rev	Description/Date	Drawn By: Storm.li	Customer:	Part No.:	254G3-GP	Third angle projection	Units: mm
△		Checked By: Simmon					X.XX ±0.50
△		Approved By: Tony		Title:	2.54 mm Wire to Board Terminal		X.XX ±0.10
SGS Report No.:							X.XXX ±0.08

SOUTH SEA TERMINAL CO., LTD

SST APPROVAL SHEET

Customer: _____

SST P/N.: 254G3-1FRXX

Customer P/N.: _____

Description: 2.54mm(.100")pitch wire to board Female Header type

Date No.: _____

Manufacturer's specification

Designed By:	Check By:	Acknowledged By:
Simmon Chang	May Yang	Tony Chou

Customer Signature

Inspected By:	Check By:	Approver By:

SOUTH SEA TERMINAL CO., LTD.

Headquarter: 6f, No.179, Sec.1, ShinTai Wu Rd. Hsi Tzih City, Taipei County, Taiwan R.O.C.

Tel: +886-2-2641-1098 Fax: +886-2-2642-8853 E-mail: sstasia@sstasia.com.tw

Web site [http// www.sstasia.com.tw](http://www.sstasia.com.tw)

Cable-Shen Zhen : B1-B2 Shang Tang Lndustry District, Zhong-Huan Nan Rd, LongHua Town, Bao'An County, Shen Zhen City, Guangdong Province, China(518131)

Tooling-China : No.4 Lndustry District, Xin Ye Rd., Xiagang Village Changan Town, Dongguan, Guangdong Province, China

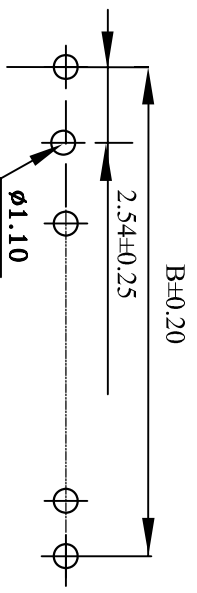
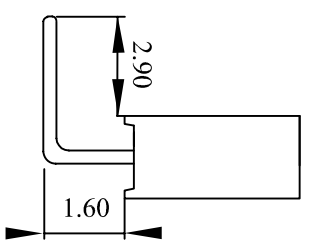
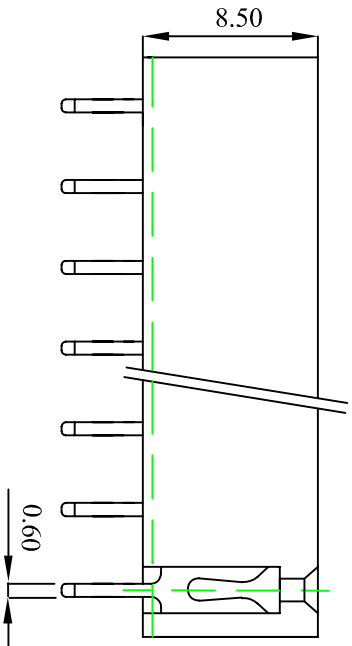
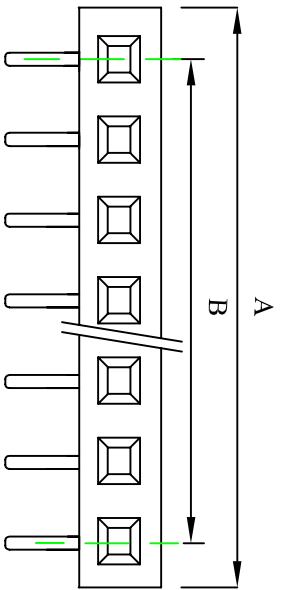

RECOMMEND P.C. BOARD LAYOUT

Material: PBT+30%GF UL 94V-0
 Pin brass gold flash
 Mate with 254G3 Series pin header
 Current rating:2.5A AC,DC
 Voltage rating:250V AC DC
 Contact resistance:30mΩMAX
 Insulation resistance:1000MΩmin
 Withstanding voltage:1500VAC/Minute
 Temperature range :-25° C to +85° C

POLES	PART NO.	DIMENSIONS(mm)		POLES	PART NO.	DIMENSIONS(mm)	
		A	B			A	B
2	254G3-1FR02	5.58	2.54	23	254G3-1FR23	58.92	55.88
3	254G3-1FR03	8.12	5.08	24	254G3-1FR24	61.46	58.42
4	254G3-1FR04	10.66	7.62	25	254G3-1FR25	64.00	60.96
5	254G3-1FR05	13.20	10.16	26	254G3-1FR26	66.54	63.50
6	254G3-1FR06	15.74	12.70	27	254G3-1FR27	69.08	66.04
7	254G3-1FR07	18.28	15.24	28	254G3-1FR28	71.62	68.58
8	254G3-1FR08	20.22	17.18	29	254G3-1FR29	74.76	71.72
9	254G3-1FR09	23.36	20.32	30	254G3-1FR30	76.70	73.66
10	254G3-1FR10	25.90	22.86	31	254G3-1FR31	79.24	76.20
11	254G3-1FR11	28.44	25.40	32	254G3-1FR32	81.78	78.74
12	254G3-1FR12	30.98	27.94	33	254G3-1FR33	84.32	81.28
13	254G3-1FR13	33.52	30.48	34	254G3-1FR34	86.86	83.82
14	254G3-1FR14	36.06	33.02	35	254G3-1FR35	89.40	86.36
15	254G3-1FR15	38.60	35.56	36	254G3-1FR36	91.94	88.90
16	254G3-1FR16	41.14	38.10	37	254G3-1FR37	94.48	91.44
17	254G3-1FR17	43.68	40.64	38	254G3-1FR38	97.02	93.98
18	254G3-1FR18	46.22	43.18	39	254G3-1FR39	99.56	96.52
19	254G3-1FR19	48.76	45.72	40	254G3-1FR40	102.10	99.06
20	254G3-1FR20	51.30	48.26	41	254G3-1FR41	104.64	101.60
21	254G3-1FR21	53.84	50.80	42	254G3-1FR42	107.18	104.14
22	254G3-1FR22	56.38	53.34	43	254G3-1FR43	109.72	106.68

Rev	Description/Date	Drawn By: Storm.li	Customer:	Part No.:	254G3-1FRXX	Third angle projection	Units: mm
△		Checked By:Simmon					
△		Approved By: Tony					

Title:		2.54mm pitch female header	
General Dimension Tolerance		XX ±0.25	XXX ±0.1
		XXX ±0.1	XXXX ±0.08

SGS Report No.:	1	2	3	4	5	6	7	8	9	10	11	12	13	14

SOUTH SEA TERMINAL CO.,LTD

SST APPROVAL SHEET

Customer: _____

Customer P/N.: _____

SST P/N.: 254G3-1FVXX

Description: 2.54mm(.100")pitch wire to board Female Header type

Approved No.: _____

Date: _____

Manufacturer's specification

Designed By:	Checked By:	Acknowledged By:
Simmon Chang	May Yang	Tony Chou

Customer Signature

Inspected By:	Checked By:	Approved By:

SOUTH SEA TERMINAL CO.,LTD.

Headquarter: 6f,No.179,Sec.1,ShinTai Wu Rd.Hsi Tzih City,Taipei County,Taiwan R.O.C.

Tel:+886-2-2641-1098 Fax:+886-2-2642-8853 E-mail:sstasia@sstasia.com.tw

Web site [http// www.sstasia.com.tw](http://www.sstasia.com.tw)

Cable-Shen Zhen : B1-B2 Shang Tang Industry District,Zhong-Huan Nan Rd,LongHua Town,Bao'An County,Shen Zhen City,Guangdong Province,China(518131)

Tooling-China : No.4 Industry District,Xin Ye Rd.,Xiagang Village Changan Town, Dongguan,Guangdong Province,China

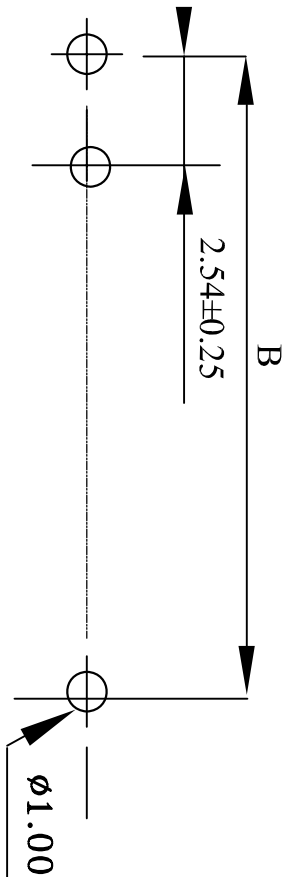
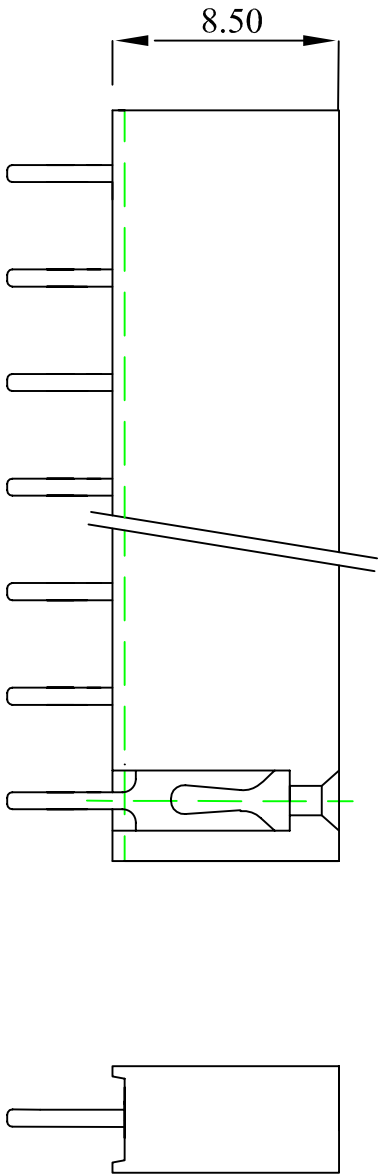
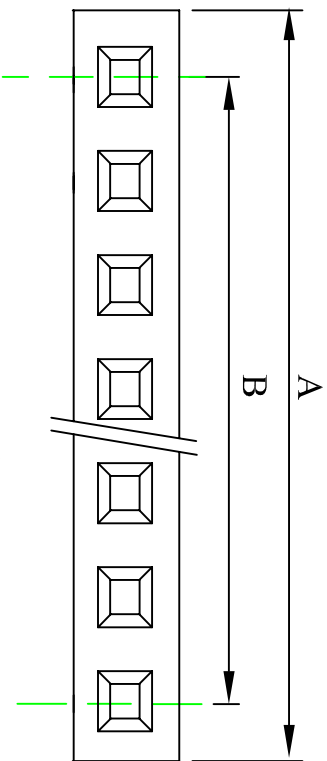

Recommend P.C. Board layout

Material: PBT+30%GF UL 94V-0
 Pin brass gold flash
 Mate with 254G3 Series pin header
 Current rating:2.5A AC,DC
 Voltage rating:250V AC DC
 Contact resistance:30mΩMAX
 Insulation resistance:1000MΩMin
 Withstanding voltage:1500VAC/Minute
 Temperature range :-25°C to +85°C

POLES	PART NO.	DIMENSIONS(mm)		POLES	PART NO.	DIMENSIONS(mm)	
		A	B			A	B
2	254G3-1FV02	5.58	2.54	23	254G3-1FV23	58.92	55.88
3	254G3-1FV03	8.12	5.08	24	254G3-1FV24	61.46	58.42
4	254G3-1FV04	10.66	7.62	25	254G3-1FV25	64.00	60.96
5	254G3-1FV05	13.20	10.16	26	254G3-1FV26	66.54	63.50
6	254G3-1FV06	15.74	12.70	27	254G3-1FV27	69.08	66.04
7	254G3-1FV07	18.28	15.24	28	254G3-1FV28	71.62	68.58
8	254G3-1FV08	20.22	17.18	29	254G3-1FV29	74.76	71.72
9	254G3-1FV09	23.36	20.32	30	254G3-1FV30	76.70	73.66
10	254G3-1FV10	25.90	22.86	31	254G3-1FV31	79.24	76.20
11	254G3-1FV11	28.44	25.40	32	254G3-1FV32	81.78	78.74
12	254G3-1FV12	30.98	27.94	33	254G3-1FV33	84.32	81.28
13	254G3-1FV13	33.52	30.48	34	254G3-1FV34	86.86	83.82
14	254G3-1FV14	36.06	33.02	35	254G3-1FV35	89.40	86.36
15	254G3-1FV15	38.60	35.56	36	254G3-1FV36	91.94	88.90
16	254G3-1FV16	41.14	38.10	37	254G3-1FV37	94.48	91.44
17	254G3-1FV17	43.68	40.64	38	254G3-1FV38	97.02	93.98
18	254G3-1FV18	46.22	43.18	39	254G3-1FV39	99.56	96.52
19	254G3-1FV19	48.76	45.72	40	254G3-1FV40	102.10	99.06
20	254G3-1FV20	51.30	48.26	41	254G3-1FV41	104.64	101.60
21	254G3-1FV21	53.84	50.80	42	254G3-1FV42	107.18	104.14
22	254G3-1FV22	56.38	53.34	43	254G3-1FV43	109.72	106.68

Rev	Description/Date	Drawn By: Storm.li	Customer:	Third angle projection	Units:
△		Checked By:Simmon	Part No.: 254G3-1FVXX		mm
△		Approved By: Tony	Title: 2.54mm pitch female header		XXX ±0.1

SGS Report No.:		2.54mm pitch female header		SOUTH SEA TERMINAL CO.,LTD	
1	2	3	4	5	6
7	8	9	10	11	12
13	14				

SST APPROVAL SHEET

Customer: _____

Customer P/N.: _____

SST P/N.: 254G3-1HXX

Description: 2.54mm(.100")pitch wire to board Housing type

Approved No.: _____

Date: _____

Manufacturer's specification

Designed By:	Checked By:	Acknowledged By:
Simmon Chang	May Yang	Tony Chou

Customer Signature

Inspected By:	Checked By:	Approved By:

SOUTH SEA TERMINAL CO.,LTD.

Headquarter: 6f,No.179,Sec.1,ShinTai Wu Rd.Hsi Tzih City,Taipei County,Taiwan R.O.C.

Tel:+886-2-2641-1098 Fax:+886-2-2642-8853 E-mail:sstasia@sstasia.com.tw

Web site [http// www.sstasia.com.tw](http://www.sstasia.com.tw)

Cable-Shen Zhen : B1-B2 Shang Tang Industry District,Zhong-Huan Nan Rd,LongHua Town,Bao'An County,Shen Zhen City,Guangdong Province,China(518131)

Tooling-China : No.4 Industry District,Xin Ye Rd.,Xiagang Village Changan Town, Dongguan,Guangdong Province,China

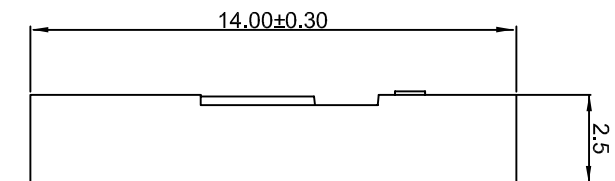
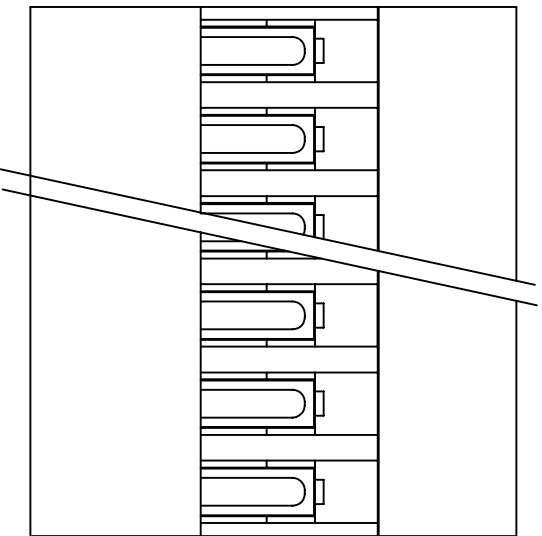
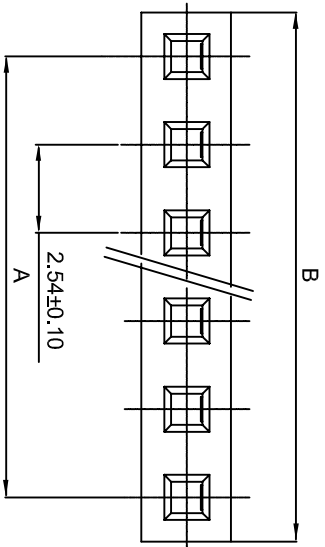

SPECIFICATIONS

- Voltage Rating : 250V AC/DC
- Current Rating : 3A AC/DC
- Withstanding Voltage : 800V AC/minute
- Insulation Resistance : 1000M Ω min
- Temperature Range : - 25° C to + 85° C

HOUSING

- Part No. : 254G3-1HXX
- Poles: 1-40
- Material : NORYL 94V-2 BLACK

Part No	Dimension		Part No	Dimension	
	A	B		A	B
254G3-1H01	2.54	53.34	254G3-1H22	53.34	55.88
254G3-1H02	2.54	5.08	254G3-1H23	55.88	58.42
254G3-1H03	5.08	7.62	254G3-1H24	58.42	60.96
254G3-1H04	7.62	10.16	254G3-1H25	60.96	63.50
254G3-1H05	10.16	12.70	254G3-1H26	63.50	66.04
254G3-1H06	12.70	15.24	254G3-1H27	66.04	68.58
254G3-1H07	15.24	17.78	254G3-1H28	68.58	71.12
254G3-1H08	17.78	20.32	254G3-1H29	71.12	73.66
254G3-1H09	20.32	22.86	254G3-1H30	73.66	76.20
254G3-1H10	22.86	25.40	254G3-1H31	76.20	78.74
254G3-1H11	25.40	27.94	254G3-1H32	78.74	81.20
254G3-1H12	27.94	30.48	254G3-1H33	81.20	83.82
254G3-1H13	30.48	33.02	254G3-1H34	83.82	86.36
254G3-1H14	33.02	35.56	254G3-1H35	86.36	88.90
254G3-1H15	35.56	38.10	254G3-1H36	88.90	91.44
254G3-1H16	38.10	40.64	254G3-1H37	91.44	93.98
254G3-1H17	40.64	43.18	254G3-1H38	93.98	96.52
254G3-1H18	43.18	45.72	254G3-1H39	96.52	99.06
254G3-1H19	45.72	48.26	254G3-1H40	99.06	101.60
254G3-1H20	48.26	50.80			
254G3-1H21	50.80	53.34			

Rev	Description/Date	Drawn By: Storm.li	Customer:	Part No.:	254G3-1HXX	Third angle projection	Units: mm
△		Checked By: Simmon			General Dimension Tolerance	$\times \times$ ± 0.50 $\times \times \times$ ± 0.10 $\times \times \times \times$ ± 0.08	
△		Approved By: Tony		Title:	2.54 mm Wire to Board Housing		
SGS Report No.:							

SOUTH SEA TERMINAL CO., LTD

SST APPROVAL SHEET

Customer: _____

Customer P/N.: _____

SST P/N.: 254G3-1LXX

Description: 2.54mm(.100")pitch wire to board Header type

Approved No.: _____

Date: _____

Manufacturer's specification

Designed By:	Checked By:	Acknowledged By:
Simmon Chang	May Yang	Tony Chou

Customer Signature

Inspected By:	Checked By:	Approved By:

SOUTH SEA TERMINAL CO.,LTD.

Headquarter: 6f,No.179,Sec.1,ShinTai Wu Rd.Hsi Tzih City,Taipei County,Taiwan R.O.C.

Tel:+886-2-2641-1098 Fax:+886-2-2642-8853 E-mail:sstasia@sstasia.com.tw

Web site [http// www.sstasia.com.tw](http://www.sstasia.com.tw)

Cable-Shen Zhen : B1-B2 Shang Tang Industry District,Zhong-Huan Nan Rd,LongHua Town,Bao'An County,Shen Zhen City,Guangdong Province,China(518131)

Tooling-China : No.4 Industry District,Xin Ye Rd.,Xiagang Village Changan Town, Dongguan,Guangdong Province,China

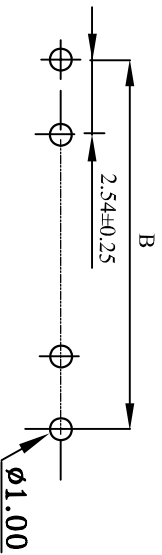
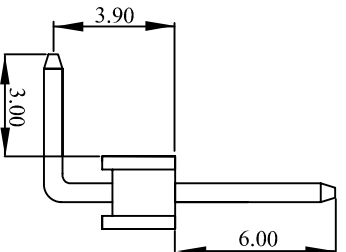
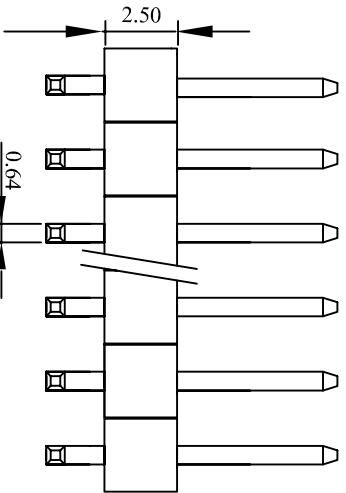
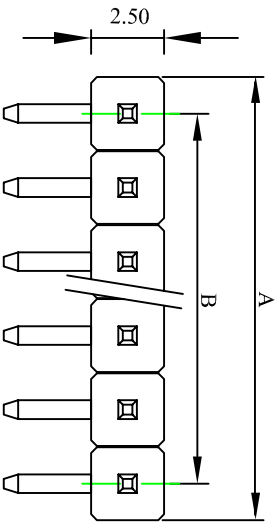

Recommend P.C. Board layout

Material: PBT+30%GF UL 94V-0
 Pin brass gold flash
 Current rating: 2.5A AC,DC
 Voltage rating: 250V AC,DC
 Contact resistance: 30mΩMAX
 Insulation resistance: 1000MΩMin
 Withstanding voltage: 1500VAC/Minute
 Temperature range : -25°C to +85°C
 SQ Pin : 0.64mm
 PC Board thickness: 0.6 to 1.2mm

POLES	PART NO.	DIMENSIONS(mm)		POLES	PART NO.	DIMENSIONS(mm)	
		A	B			A	B
1	254G3-1L01	2.54		22	254G3-1L22	55.88	53.34
2	254G3-1L02	5.08	2.54	23	254G3-1L23	58.42	55.88
3	254G3-1L03	7.62	5.08	24	254G3-1L24	60.96	58.42
4	254G3-1L04	10.16	7.62	25	254G3-1L25	63.50	60.96
5	254G3-1L05	12.7	10.16	26	254G3-1L26	66.04	63.50
6	254G3-1L06	15.24	12.70	27	254G3-1L27	68.58	66.04
7	254G3-1L07	17.78	15.24	28	254G3-1L28	71.12	68.58
8	254G3-1L08	20.32	17.78	29	254G3-1L29	73.66	71.12
9	254G3-1L09	22.86	20.32	30	254G3-1L30	76.20	73.66
10	254G3-1L10	25.40	22.86	31	254G3-1L31	78.74	76.20
11	254G3-1L11	27.94	25.40	32	254G3-1L32	81.28	78.74
12	254G3-1L12	30.48	27.94	33	254G3-1L33	83.82	81.28
13	254G3-1L13	33.02	30.48	34	254G3-1L34	86.36	83.82
14	254G3-1L14	35.56	33.02	35	254G3-1L35	88.90	86.36
15	254G3-1L15	38.10	35.56	36	254G3-1L36	91.44	88.90
16	254G3-1L16	40.64	38.10	37	254G3-1L37	93.98	91.44
17	254G3-1L17	43.18	40.64	38	254G3-1L38	96.52	93.98
18	254G3-1L18	45.72	43.18	39	254G3-1L39	99.06	96.52
19	254G3-1L19	48.26	45.72	40	254G3-1L40	101.60	99.06
20	254G3-1L20	50.80	48.26				
21	254G3-1L21	53.34	50.80				

Rev	Description/Date	Drawn By: Storm.li	Customer:	Third angle projection	Units: mm
△		Checked By: Simmon	Part No.: 254G3-1LXX		XXX ±0.25 XXX ±0.1 XXX ±0.08
△		Approved By: Tony	Title: Pin Header(Low profile)		

SGS Report No.:			SOUTH SEA TERMINAL CO.,LTD	
-----------------	--	--	----------------------------	--

SST APPROVAL SHEET

Customer: _____

Customer P/N.: _____

SST P/N.: 254G3-1RXX

Description: 2.54mm(.100")pitch wire to board Header type

Approved No.: _____

Date: _____

Manufacturer's specification

Designed By:	Checked By:	Acknowledged By:
Simmon Chang	May Yang	Tony Chou

Customer Signature

Inspected By:	Checked By:	Approved By:

SOUTH SEA TERMINAL CO.,LTD.

Headquarter: 6f,No.179,Sec.1,ShinTai Wu Rd.Hsi Tzih City,Taipei County,Taiwan R.O.C.

Tel:+886-2-2641-1098 Fax:+886-2-2642-8853 E-mail:sstasia@sstasia.com.tw

Web site [http// www.sstasia.com.tw](http://www.sstasia.com.tw)

Cable-Shen Zhen : B1-B2 Shang Tang Industry District,Zhong-Huan Nan Rd,LongHua Town,Bao'An County,Shen Zhen City,Guangdong Province,China(518131)

Tooling-China : No.4 Industry District,Xin Ye Rd.,Xiagang Village Changan Town, Dongguan,Guangdong Province,China

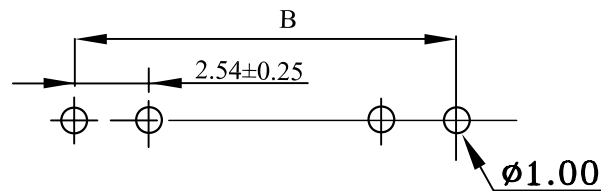
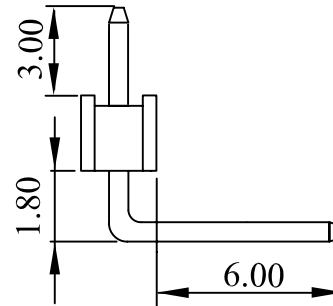
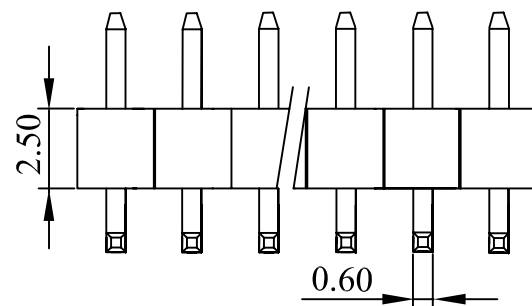
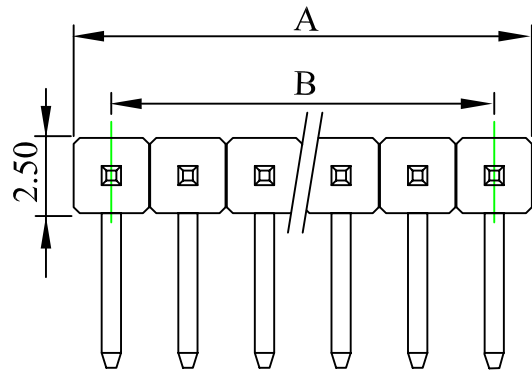

Recommend P.C. Board layout

Material: PBT+30%GF UL 94V-0

Pin brass gold flash

Current rating: 2.5AAC, DC

Voltage rating: 250V AC DC

Contact resistance: 30mΩMAX

Insulation resistance: 1000MΩMin

Withstanding voltage: 1500VAC/Minute

Temperature range: -25°C to +85°C

SQ Pin : 0.64mm

PC Board thickness: 0.6 to 1.2mm

POLES	PART NO.	DIMMENSIONS(mm)		POLES	PART NO.	DIMMENSIONS(mm)	
		A	B			A	B
1	254G3-1R01	2.54		22	254G3-1R22	55.88	53.34
2	254G3-1R02	5.08	2.54	23	254G3-1R23	58.42	55.88
3	254G3-1R03	7.62	5.08	24	254G3-1R24	60.96	58.42
4	254G3-1R04	10.16	7.62	25	254G3-1R25	63.50	60.96
5	254G3-1R05	12.7	10.16	26	254G3-1R26	66.04	63.50
6	254G3-1R06	15.24	12.70	27	254G3-1R27	68.58	66.04
7	254G3-1R07	17.78	15.24	28	254G3-1R28	71.72	68.58
8	254G3-1R08	20.32	17.78	29	254G3-1R29	73.66	71.72
9	254G3-1R09	22.86	20.32	30	254G3-1R30	76.20	73.66
10	254G3-1R10	25.40	22.86	31	254G3-1R31	78.74	76.20
11	254G3-1R11	27.94	25.40	32	254G3-1R32	81.28	78.74
12	254G3-1R12	30.48	27.94	33	254G3-1R33	83.82	81.28
13	254G3-1R13	33.02	30.48	34	254G3-1R34	86.36	83.82
14	254G3-1R14	35.56	33.02	35	254G3-1R35	88.90	86.36
15	254G3-1R15	38.10	35.56	36	254G3-1R36	91.44	88.90
16	254G3-1R16	40.64	38.10	37	254G3-1R37	93.98	91.44
17	254G3-1R17	43.18	40.64	38	254G3-1R38	96.52	93.98
18	254G3-1R18	45.72	43.18	39	254G3-1R39	99.06	96.52
19	254G3-1R19	48.26	45.72	40	254G3-1R40	101.60	99.06
20	254G3-1R20	50.80	48.26				
21	254G3-1R21	53.34	50.80				

Rev	Description/Date	Drawn By: Storm.li	Customer:
△		Checked By: Simmon	Part No.: 254G3-1RXX
△		Approved By: Tony	Title: 2.54mm pitch pin header

SGS Report No.:	
-----------------	--

Third angle projection		Units: mm
General Dimension Tolerance	X.X ±0.25	X.XX ±0.1
	X.XXX ±0.08	

SOUTH SEA TERMINAL CO., LTD

SST APPROVAL SHEET

Customer: _____

Customer P/N.: _____

SST P/N.: 254G3-1VXX

Description: 2.54mm(.100")pitch wire to board Header type

Approved No.: _____

Date: _____

Manufacturer's specification

Designed By:	Checked By:	Acknowledged By:
Simmon Chang	May Yang	Tony Chou

Customer Signature

Inspected By:	Checked By:	Approved By:

SOUTH SEA TERMINAL CO.,LTD.

Headquarter: 6f,No.179,Sec.1,ShinTai Wu Rd.Hsi Tzih City,Taipei County,Taiwan R.O.C.

Tel:+886-2-2641-1098 Fax:+886-2-2642-8853 E-mail:sstasia@sstasia.com.tw

Web site [http// www.sstasia.com.tw](http://www.sstasia.com.tw)

Cable-Shen Zhen : B1-B2 Shang Tang Industry District,Zhong-Huan Nan Rd,LongHua Town,Bao'An County,Shen Zhen City,Guangdong Province,China(518131)

Tooling-China : No.4 Industry District,Xin Ye Rd.,Xiagang Village Changan Town, Dongguan,Guangdong Province,China

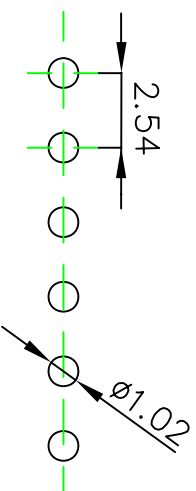
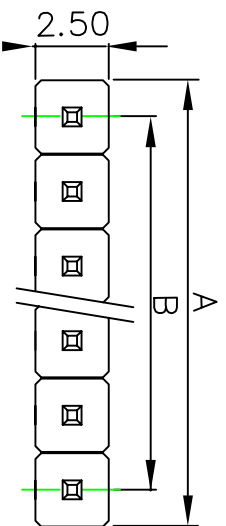

Recommended P.C.B. Layout

Material: PBT+30%GF UL 94V-0
 Pin brass gold flash
 Current rating: 2.5A AC,DC
 Voltage rating: 250V AC DC
 Contact resistance: 30mΩMAX
 Insulation resistance: 1000MΩ/Min
 Withstanding voltage: 1500VAC/Minute
 Temperature range : -25°C to +85°C
 SQ Pin : 0.64mm
 PC Board thickness: 0.6 to 1.2mm

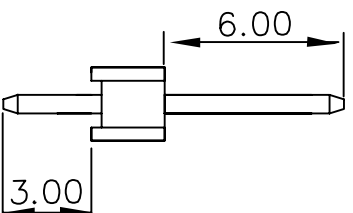
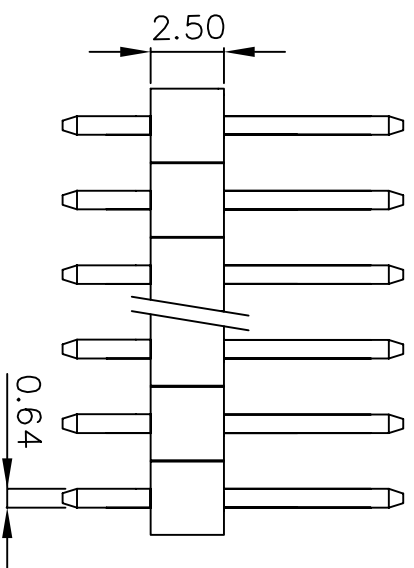

POLES	PART NO.	DIMENSIONS(mm)		POLES	PART NO.	DIMENSIONS(mm)	
		A	B			A	B
1	254G3-1V01	2.54		22	254G3-1V22	55.88	53.34
2	254G3-1V02	5.08	2.54	23	254G3-1V23	58.42	55.88
3	254G3-1V03	7.62	5.08	24	254G3-1V24	60.96	58.42
4	254G3-1V04	10.16	7.62	25	254G3-1V25	63.50	60.96
5	254G3-1V05	12.7	10.16	26	254G3-1V26	66.04	63.50
6	254G3-1V06	15.24	12.70	27	254G3-1V27	68.58	66.04
7	254G3-1V07	17.78	15.24	28	254G3-1V28	71.12	68.58
8	254G3-1V08	20.32	17.78	29	254G3-1V29	73.66	71.12
9	254G3-1V09	22.86	20.32	30	254G3-1V30	76.20	73.66
10	254G3-1V10	25.40	22.86	31	254G3-1V31	78.74	76.20
11	254G3-1V11	27.94	25.40	32	254G3-1V32	81.28	78.74
12	254G3-1V12	30.48	27.94	33	254G3-1V33	83.82	81.28
13	254G3-1V13	33.02	30.48	34	254G3-1V34	86.36	83.82
14	254G3-1V14	35.56	33.02	35	254G3-1V35	88.90	86.36
15	254G3-1V15	38.10	35.56	36	254G3-1V36	91.44	88.90
16	254G3-1V16	40.64	38.10	37	254G3-1V37	93.98	91.44
17	254G3-1V17	43.18	40.64	38	254G3-1V38	96.52	93.98
18	254G3-1V18	45.72	43.18	39	254G3-1V39	99.06	96.52
19	254G3-1V19	48.26	45.72	40	254G3-1V40	101.60	99.06
20	254G3-1V20	50.80	48.26				
21	254G3-1V21	53.34	50.80				

Rev Description/Date Drawn By: Storm.li

Checked By: Simmon Approved By: Tony

Customer: Part No.: 254G3-1VXX(1xN)

Title: 2.54 mm Pin Header

Third angle projection Units: mm

General Dimension Tolerance X.X ±0.50 XXX ±0.10 XXXX ±0.08

SGS Report No.:

SOUTH SEA TERMINAL CO., LTD

SST APPROVAL SHEET

Customer: _____

Customer P/N.: _____

SST P/N.: 254G3-2FRXX

Description: 2.54mm(.100")pitch wire to board Female Header type

Approved No.: _____

Date: _____

Manufacturer's specification

Designed By:	Checked By:	Acknowledged By:
Simmon Chang	May Yang	Tony Chou

Customer Signature

Inspected By:	Checked By:	Approved By:

SOUTH SEA TERMINAL CO.,LTD.

Headquarter: 6f,No.179,Sec.1,ShinTai Wu Rd.Hsi Tzih City,Taipei County,Taiwan R.O.C.

Tel:+886-2-2641-1098 Fax:+886-2-2642-8853 E-mail:sstasia@sstasia.com.tw

Web site [http// www.sstasia.com.tw](http://www.sstasia.com.tw)

Cable-Shen Zhen : B1-B2 Shang Tang Industry District,Zhong-Huan Nan Rd,LongHua Town,Bao'An County,Shen Zhen City,Guangdong Province,China(518131)

Tooling-China : No.4 Industry District,Xin Ye Rd.,Xiagang Village Changan Town, Dongguan,Guangdong Province,China

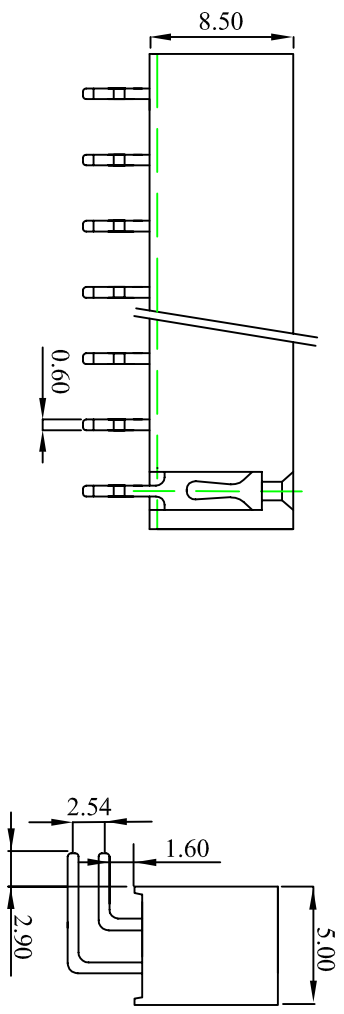
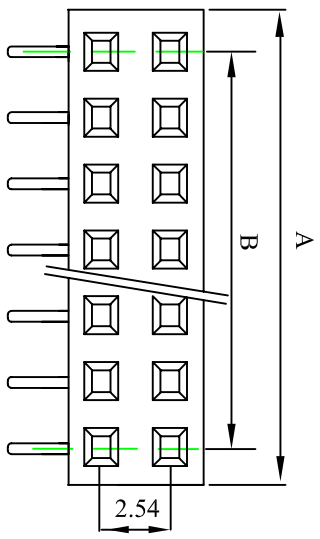

Material: PBT+30%GF UL 94V-0
 Pin brass gold flash
 Mate with 254G3 Series pin header
 Current rating:2.5A AC,DC
 Voltage rating:250V AC DC
 Contact resistance:30mΩMAX
 Insulation resistance:1000MΩMin
 Withstanding voltage:1500VAC/Minute
 Temperature range :-25°C to +85°C

POLES	PART NO.	DIMENSIONS(mm)		POLES	PART NO.	DIMENSIONS(mm)	
		A	B			A	B
4	254G3-2FR04	5.58	2.54	46	254G3-2FR46	58.92	55.88
6	254G3-2FR06	8.12	5.08	48	254G3-2FR48	61.46	58.42
8	254G3-2FR08	10.66	7.62	50	254G3-2FR50	64.00	60.96
10	254G3-2FR10	13.20	10.16	52	254G3-2FR52	66.54	63.50
12	254G3-2FR12	15.74	12.70	54	254G3-2FR54	69.08	66.04
14	254G3-2FR14	18.28	15.24	56	254G3-2FR56	71.62	68.58
16	254G3-2FR16	20.22	17.18	58	254G3-2FR58	74.76	71.72
18	254G3-2FR18	23.36	20.32	60	254G3-2FR60	76.70	73.66
20	254G3-2FR20	25.90	22.86	62	254G3-2FR62	79.24	76.20
22	254G3-2FR22	28.44	25.40	64	254G3-2FR64	81.78	78.74
24	254G3-2FR24	30.98	27.94	66	254G3-2FR66	84.32	81.28
26	254G3-2FR26	33.52	30.48	68	254G3-2FR68	86.86	83.82
28	254G3-2FR28	36.06	33.02	70	254G3-2FR70	89.40	86.36
30	254G3-2FR30	38.60	35.56	72	254G3-2FR72	91.94	88.90
32	254G3-2FR32	41.14	38.10	74	254G3-2FR74	94.48	91.44
34	254G3-2FR34	43.68	40.64	76	254G3-2FR76	97.02	93.98
36	254G3-2FR36	46.22	43.18	78	254G3-2FR78	99.56	96.52
38	254G3-2FR38	48.76	45.72	80	254G3-2FR80	102.10	99.06
40	254G3-2FR40	51.30	48.26	82	254G3-2FR82	104.64	101.60
42	254G3-2FR42	53.84	50.80	84	254G3-2FR84	107.18	104.14
44	254G3-2FR44	56.38	53.34	86	254G3-2FR86	109.72	106.68

Recommend P.C Board layout

Rev	Description/Date	Drawn By: Storm.li	Customer:
△		Checked By:Simmon	Part No.: 254G3-2FRXX
△		Approved By: Tony	
SGS Report No.:		Title:	2.54mm pitch female header

Third angle projection		Units: mm
General Dimension Tolerance		XX ±0.25 XXX ±0.1 XXXX ±0.08

SOUTH SEA TERMINAL CO.,LTD

SST APPROVAL SHEET

Customer: _____

Customer P/N.: _____

SST P/N.: 254G3-2FVXX

Description: 2.54mm(.100")pitch wire to board Female Header type

Approved No.: _____

Date: _____

Manufacturer's specification

Designed By:	Checked By:	Acknowledged By:
Simmon Chang	May Yang	Tony Chou

Customer Signature

Inspected By:	Checked By:	Approved By:

SOUTH SEA TERMINAL CO.,LTD.

Headquarter: 6f,No.179,Sec.1,ShinTai Wu Rd.Hsi Tzih City,Taipei County,Taiwan R.O.C.

Tel:+886-2-2641-1098 Fax:+886-2-2642-8853 E-mail:sstasia@sstasia.com.tw

Web site [http// www.sstasia.com.tw](http://www.sstasia.com.tw)

Cable-Shen Zhen : B1-B2 Shang Tang Industry District,Zhong-Huan Nan Rd,LongHua Town,Bao'An County,Shen Zhen City,Guangdong Province,China(518131)

Tooling-China : No.4 Industry District,Xin Ye Rd.,Xiagang Village Changan Town, Dongguan,Guangdong Province,China

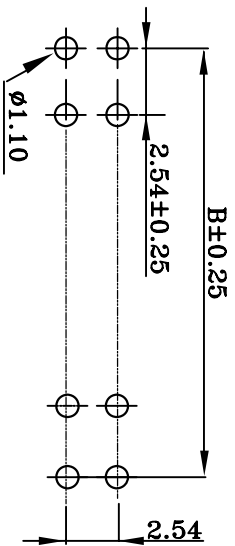
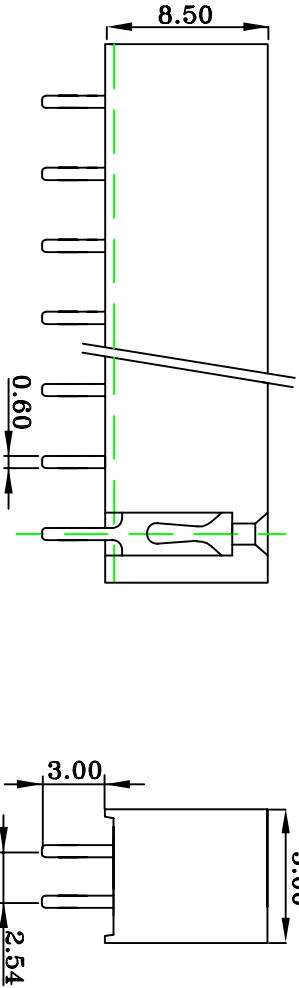
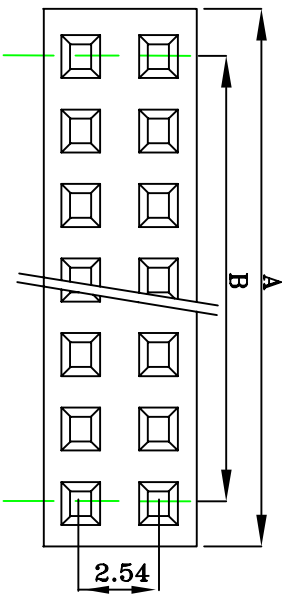

Recommend P.C. Board layout

Material: PBT+30%GF UL 94V-0
 Pin brass gold flash
 Mate with 254G3 Series pin header
 Current rating:2.5A AC,DC
 Voltage rating:250V AC,DC
 Contact resistance:30mΩMAX
 Insulation resistance:1000MΩMin
 Withstanding voltage:1500VAC/Minute
 Temperature range : -25° C to +85° C

POLES	PART NO.	DIMENSIONS(mm)		POLES	PART NO.	DIMENSIONS(mm)	
		A	B			A	B
4	254G3-2FV04	5.58	2.54	46	254G3-2FV46	58.92	55.88
6	254G3-2FV06	8.12	5.08	48	254G3-2FV48	61.46	58.42
8	254G3-2FV08	10.66	7.62	50	254G3-2FV50	64.00	60.96
10	254G3-2FV10	13.20	10.16	52	254G3-2FV52	66.54	63.50
12	254G3-2FV12	15.74	12.70	54	254G3-2FV54	69.08	66.04
14	254G3-2FV14	18.28	15.24	56	254G3-2FV56	71.62	68.58
16	254G3-2FV16	20.22	17.18	58	254G3-2FV58	74.76	71.72
18	254G3-2FV18	23.36	20.32	60	254G3-2FV60	76.70	73.66
20	254G3-2FV20	25.90	22.86	62	254G3-2FV62	79.24	76.20
22	254G3-2FV22	28.44	25.40	64	254G3-2FV64	81.78	78.74
24	254G3-2FV24	30.98	27.94	66	254G3-2FV66	84.32	81.28
26	254G3-2FV26	33.52	30.48	68	254G3-2FV68	86.86	83.82
28	254G3-2FV28	36.06	33.02	70	254G3-2FV70	89.40	86.36
30	254G3-2FV30	38.60	35.56	72	254G3-2FV72	91.94	88.90
32	254G3-2FV32	41.14	38.10	74	254G3-2FV74	94.48	91.44
34	254G3-2FV34	43.68	40.64	76	254G3-2FV76	97.02	93.98
36	254G3-2FV36	46.22	43.18	78	254G3-2FV78	99.56	96.52
38	254G3-2FV38	48.76	45.72	80	254G3-2FV80	102.10	99.06
40	254G3-2FV40	51.30	48.26	82	254G3-2FV82	104.64	101.60
42	254G3-2FV42	53.84	50.80	84	254G3-2FV84	107.18	104.14
44	254G3-2FV44	56.38	53.34	86	254G3-2FV86	109.72	106.68

Third angle projection



Units: mm

General Dimension Tolerance

XX ±0.25 XXX ±0.1 XXXX ±0.08

Title: 2.54mm pitch female header

SOUTH SEA TERMINAL CO.,LTD

Rev Description/Date

Drawn By: Storm.li
 Checked By: Simmon
 Approved By: Tony

Customer:

Part No.: 254G3-2FVXX

SGS Report No.:

1 2 3 4 5 6 7 8 9 10 11 12 13 14

SST APPROVAL SHEET

Customer: _____

Customer P/N.: _____

SST P/N.: 254G3-2HXX

Description: 2.54mm(.100")pitch wire to board Housing type

Approved No.: _____

Date: _____

Manufacturer's specification

Designed By:	Checked By:	Acknowledged By:
Simmon Chang	May Yang	Tony Chou

Customer Signature

Inspected By:	Checked By:	Approved By:

SOUTH SEA TERMINAL CO.,LTD.

Headquarter: 6f,No.179,Sec.1,ShinTai Wu Rd.Hsi Tzih City,Taipei County,Taiwan R.O.C.

Tel:+886-2-2641-1098 Fax:+886-2-2642-8853 E-mail:sstasia@sstasia.com.tw

Web site [http// www.sstasia.com.tw](http://www.sstasia.com.tw)

Cable-Shen Zhen : B1-B2 Shang Tang Industry District,Zhong-Huan Nan Rd,LongHua Town,Bao'An County,Shen Zhen City,Guangdong Province,China(518131)

Tooling-China : No.4 Industry District,Xin Ye Rd.,Xiagang Village Changan Town, Dongguan,Guangdong Province,China

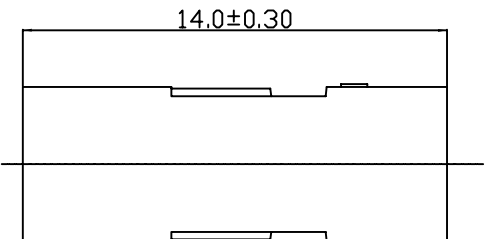
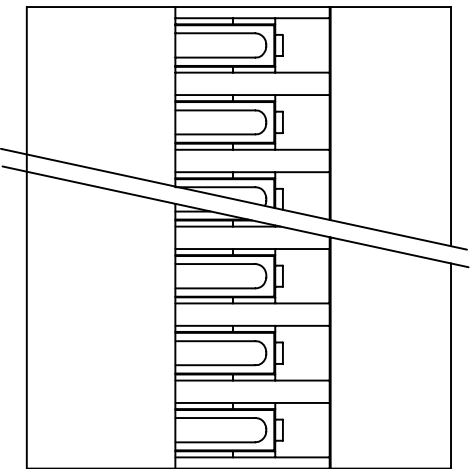
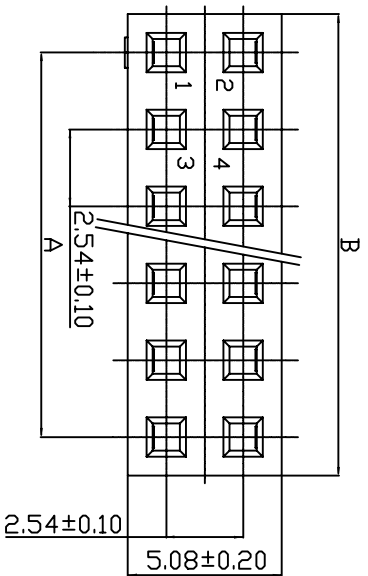

Part No	Dimension		Part No	Dimension	
	A	B		A	B
254G3-2H02	2.54	5.08	254G3-2H22	53.34	55.88
254G3-2H03	5.08	7.62	254G3-2H23	55.88	58.42
254G3-2H04	7.62	10.16	254G3-2H24	58.42	60.96
254G3-2H05	10.16	12.70	254G3-2H25	60.96	63.50
254G3-2H06	12.70	15.24	254G3-2H26	63.50	66.04
254G3-2H07	15.24	17.78	254G3-2H27	66.04	68.58
254G3-2H08	17.78	20.32	254G3-2H28	68.58	71.12
254G3-2H09	20.32	22.86	254G3-2H29	71.12	73.66
254G3-2H10	22.86	25.40	254G3-2H30	73.66	76.20
254G3-2H11	25.40	27.94	254G3-2H31	76.20	78.74
254G3-2H12	27.94	30.48	254G3-2H32	78.74	81.20
254G3-2H13	30.48	33.02	254G3-2H33	81.20	83.82
254G3-2H14	33.02	35.56	254G3-2H34	83.82	86.36
254G3-2H15	35.56	38.10	254G3-2H35	86.36	88.90
254G3-2H16	38.10	40.64	254G3-2H36	88.90	91.44
254G3-2H17	40.64	43.18	254G3-2H37	91.44	93.98
254G3-2H18	43.18	45.72	254G3-2H38	93.98	96.52
254G3-2H19	45.72	48.26	254G3-2H39	96.52	99.06
254G3-2H20	48.26	50.80	254G3-2H40	99.06	101.60
254G3-2H21	50.80	53.34			

- SPECIFICATIONS**
- Voltage Rating : 250V AC/DC
 - Current Rating : 3A AC/DC
 - Withstanding Voltage : 800V AC/minute
 - Insulation Resistance : 1000M Ω min
 - Temperature Range : - 25°C to + 85°C

- HOUSING**
- Part No. : 254G3-2HXX(2xPin)
 - Poles: 2-80
 - Material : NDRYL 94V-2 BLACK

Rev Description/Date Drawn By: Storm.li

Customer:

Part No.: 254G3-2HXX

Third angle projection



Units: mm

Checked By: Simmon
Approved By: Tony

Title:

2.54 mm Wire to Board Housing

General Dimension Tolerance

X.X ±0.50
X.XX ±0.10
X.XXX ±0.08

SGS Report No.:

SOUTH SEA TERMINAL CO., LTD

SST APPROVAL SHEET

Customer: _____

Customer P/N.: _____

SST P/N.: 254G3-2LXX

Description: 2.54mm(.100")pitch wire to board Header type

Approved No.: _____

Date: _____

Manufacturer's specification

Designed By:	Checked By:	Acknowledged By:
Simmon Chang	May Yang	Tony Chou

Customer Signature

Inspected By:	Checked By:	Approved By:

SOUTH SEA TERMINAL CO.,LTD.

Headquarter: 6f,No.179,Sec.1,ShinTai Wu Rd.Hsi Tzih City,Taipei County,Taiwan R.O.C.

Tel:+886-2-2641-1098 Fax:+886-2-2642-8853 E-mail:sstasia@sstasia.com.tw

Web site [http// www.sstasia.com.tw](http://www.sstasia.com.tw)

Cable-Shen Zhen : B1-B2 Shang Tang Industry District,Zhong-Huan Nan Rd,LongHua Town,Bao'An County,Shen Zhen City,Guangdong Province,China(518131)

Tooling-China : No.4 Industry District,Xin Ye Rd.,Xiagang Village Changan Town, Dongguan,Guangdong Province,China

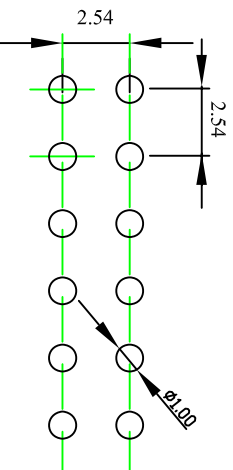
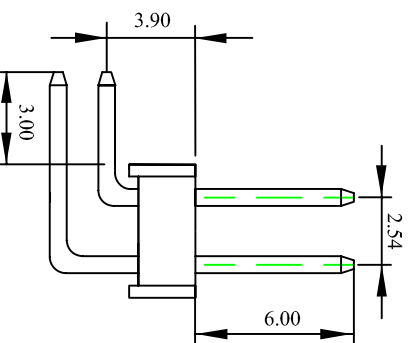
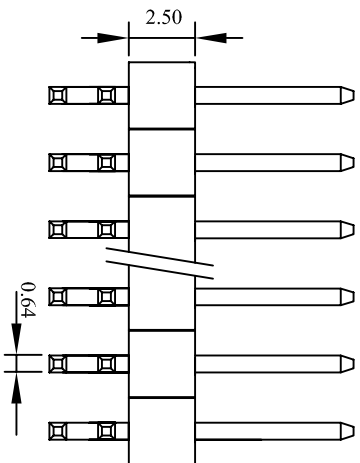
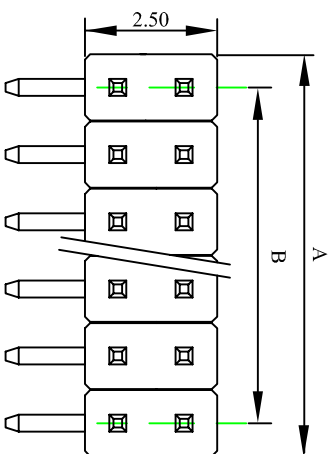

Recommended P.C. Board layout

Material: PBT+30%GF UL 94V-0
 Pin brass gold flash
 Current rating:2.5A AC,DC
 Voltage rating:250V AC DC
 Contact resistance:30mΩMAX
 Insulation resistance:1000MΩ/Min
 Withstanding voltage:1500VAC/Minute
 Temperature range :-25°C to +85°C
 SQ Pin : 0.64mm
 PC Board thickness: 0.6 to 1.2mm

POLES	PART NO.	DIMENSIONS(mm)		POLES	PART NO.	DIMENSIONS(mm)	
		A	B			A	B
2	254G3-2L02	2.54		44	254G3-2L44	55.88	53.34
4	254G3-2L04	5.08	2.54	46	254G3-2L46	58.42	55.88
6	254G3-2L06	7.62	5.08	48	254G3-2L48	60.96	58.42
8	254G3-2L08	10.16	7.62	50	254G3-2L50	63.50	60.96
10	254G3-2L10	12.7	10.16	52	254G3-2L52	66.04	63.50
12	254G3-2L12	15.24	12.70	54	254G3-2L54	68.58	66.04
14	254G3-2L14	17.78	15.24	56	254G3-2L56	71.12	68.58
16	254G3-2L16	20.32	17.78	58	254G3-2L58	73.66	71.12
18	254G3-2L18	22.86	20.32	60	254G3-2L60	76.20	73.66
20	254G3-2L20	25.40	22.86	62	254G3-2L62	78.74	76.20
22	254G3-2L22	27.94	25.40	64	254G3-2L64	81.28	78.74
24	254G3-2L24	30.48	27.94	66	254G3-2L66	83.82	81.28
26	254G3-2L26	33.02	30.48	68	254G3-2L68	86.36	83.82
28	254G3-2L28	35.56	33.02	70	254G3-2L70	88.90	86.36
30	254G3-2L30	38.10	35.56	72	254G3-2L72	91.44	88.90
32	254G3-2L32	40.64	38.10	74	254G3-2L74	93.98	91.44
34	254G3-2L34	43.18	40.64	76	254G3-2L76	96.52	93.98
36	254G3-2L36	45.72	43.18	78	254G3-2L78	99.06	96.52
38	254G3-2L38	48.26	45.72	80	254G3-2L80	101.60	99.06
40	254G3-2L40	50.80	48.26				
42	254G3-2L42	53.34	50.80				

Third angle projection



Units: mm

General Dimension Tolerance

XX ±0.25 XXX ±0.1 XXXX ±0.08

Rev	Description/Date	Drawn By: Storm.li
△		Checked By:Simmon
△		Approved By: Tony
SGS Report No.:		

Customer:	Part No.:
	254G3-2LXX
Title:	Pin Header(Low profile)

SOUTH SEA TERMINAL CO.,LTD

SST APPROVAL SHEET

Customer: _____

Customer P/N.: _____

SST P/N.: 254G3-2VXX

Description: 2.54mm(.100")pitch wire to board Header type

Approved No.: _____

Date: _____

Manufacturer's specification

Designed By:	Checked By:	Acknowledged By:
Simmon Chang	May Yang	Tony Chou

Customer Signature

Inspected By:	Checked By:	Approved By:

SOUTH SEA TERMINAL CO.,LTD.

Headquarter: 6f,No.179,Sec.1,ShinTai Wu Rd.Hsi Tzih City,Taipei County,Taiwan R.O.C.

Tel:+886-2-2641-1098 Fax:+886-2-2642-8853 E-mail:sstasia@sstasia.com.tw

Web site [http// www.sstasia.com.tw](http://www.sstasia.com.tw)

Cable-Shen Zhen : B1-B2 Shang Tang Industry District,Zhong-Huan Nan Rd,LongHua Town,Bao'An County,Shen Zhen City,Guangdong Province,China(518131)

Tooling-China : No.4 Industry District,Xin Ye Rd.,Xiagang Village Changan Town, Dongguan,Guangdong Province,China

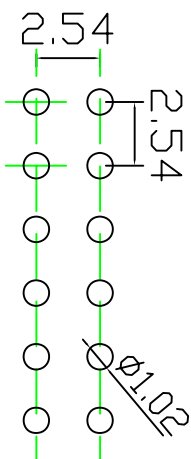
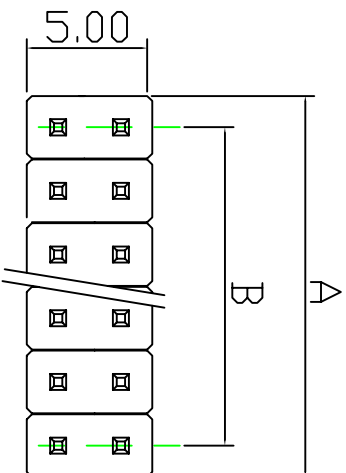

Recommended
P.C.Board layout

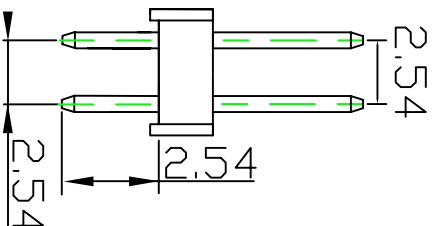
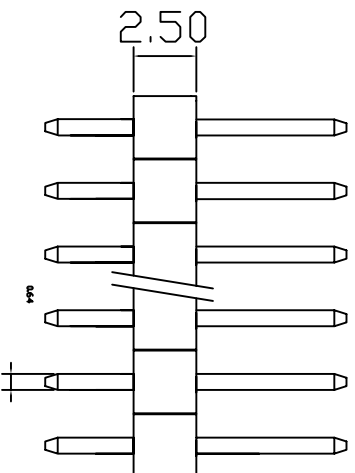

Material: PBT+30%GF UL 94V-0
 Pin brass gold flash
 Current rating:2.5A AC,DC
 Voltage rating:250V AC DC
 Contact resistance:30mΩMAX
 Insulation resistance:1000MΩMin
 Withstanding voltage:1500VAC/Minute
 Temperature range :-25°C to +85°C
 SQ Pin : 0.64mm
 PC Board thickness: 0.6 to 1.2mm

Poles	Part No.	Dimension(mm)		Poles	Part No.	Dimension(mm)	
		A	B			A	B
2	254G3-2V02	2.54		44	254G3-2V44	55.88	53.34
4	254G3-2V04	5.08	2.54	46	254G3-2V46	58.42	55.88
6	254G3-2V06	7.62	5.08	48	254G3-2V48	60.96	58.42
8	254G3-2V08	10.16	7.62	50	254G3-2V50	63.50	60.96
10	254G3-2V10	12.70	10.16	52	254G3-2V52	66.04	63.50
12	254G3-2V12	15.24	12.70	54	254G3-2V54	68.58	66.04
14	254G3-2V14	17.78	15.24	56	254G3-2V56	71.12	68.58
16	254G3-2V16	20.32	17.78	58	254G3-2V58	73.66	71.12
18	254G3-2V18	22.86	20.32	60	254G3-2V60	76.20	73.66
20	254G3-2V20	25.40	22.86	62	254G3-2V62	78.74	76.20
22	254G3-2V22	27.94	25.40	64	254G3-2V64	81.28	78.74
24	254G3-2V24	30.48	27.94	66	254G3-2V66	83.82	81.28
26	254G3-2V26	33.02	30.48	68	254G3-2V68	86.36	83.82
28	254G3-2V28	35.56	33.02	70	254G3-2V70	88.90	86.36
30	254G3-2V30	38.10	35.56	72	254G3-2V72	91.44	88.90
32	254G3-2V32	40.64	38.10	74	254G3-2V74	93.98	91.44
34	254G3-2V34	43.18	40.64	76	254G3-2V76	96.52	93.98
36	254G3-2V36	45.72	43.18	78	254G3-2V78	99.06	96.52
38	254G3-2V38	48.26	45.72	80	254G3-2V80	101.60	99.06
40	254G3-2V40	50.80	48.26				
42	254G3-2V42	53.34	50.80				

Third angle projection



Units:
mm

General Dimension Tolerance

X.X ±0.50 X.XX ±0.10 XXXX ±0.08

Rev	Description/Date	Drawn By: Storm.li
△		Checked By:Simmon
△		Approved By: Tony
SGS Report No.:		

Customer:	
Part No.:	254G3-2VXX(2XN)
Title:	2.54 mm Pin Header

SOUTH SEA TERMINAL CO.,LTD

SST APPROVAL SHEET

Customer: _____

Customer P/N.: _____

SST P/N.: 254G3-2VXXDL

Description: 2.54mm(.100")pitch wire to board Pin Header type

Approved No.: _____

Date: _____

Manufacturer's specification

Designed By:	Checked By:	Acknowledged By:
Simmon Chang	May Yang	Tony Chou

Customer Signature

Inspected By:	Checked By:	Approved By:

SOUTH SEA TERMINAL CO.,LTD.

Headquarter: 6f,No.179,Sec.1,ShinTai Wu Rd.Hsi Tzih City,Taipei County,Taiwan R.O.C.

Tel:+886-2-2641-1098 Fax:+886-2-2642-8853 E-mail:sstasia@sstasia.com.tw

Web site [http// www.sstasia.com.tw](http://www.sstasia.com.tw)

Cable-Shen Zhen : B1-B2 Shang Tang Industry District,Zhong-Huan Nan Rd,LongHua Town,Bao'An County,Shen Zhen City,Guangdong Province,China(518131)

Tooling-China : No.4 Industry District,Xin Ye Rd.,Xiagang Village Changan Town, Dongguan,Guangdong Province,China

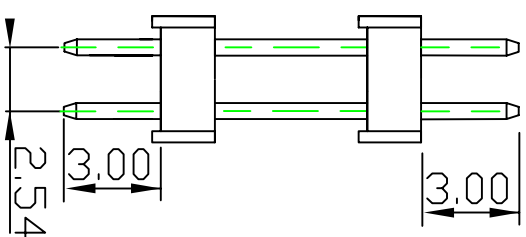
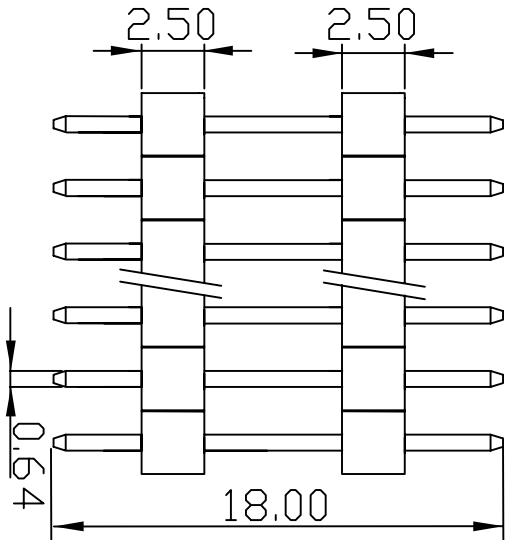
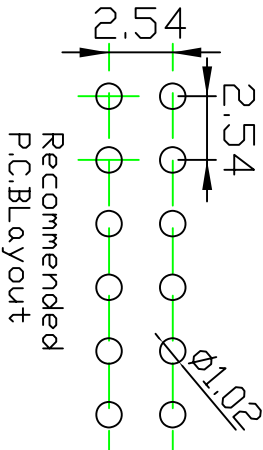
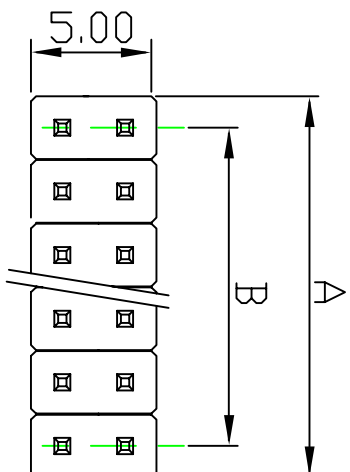

Material: PBT+30%GF UL 94V-0
 Pin brass gold flash
 Current rating:2.5A AC,DC
 Voltage rating:250V AC DC
 Contact resistance:30mΩMAX
 Insulation resistance:1000MΩMin
 Withstanding voltage:1500VAC/Minute
 Temperature range :-25°C to +85°C
 SQ Pin : 0.64mm
 PC Board thickness: 0.6 to 1.2mm

Poles	Part No.	Dimension(mm)		Poles	Part No.	Dimension(mm)	
		A	B			A	B
2	254G3-2V02DL	2.54		44	254G3-2V44DL	55.88	53.34
4	254G3-2V04DL	5.08	2.54	46	254G3-2V46DL	58.42	55.88
6	254G3-2V06DL	7.62	5.08	48	254G3-2V48DL	60.96	58.42
8	254G3-2V08DL	10.16	7.62	50	254G3-2V50DL	63.50	60.96
10	254G3-2V10DL	12.70	10.16	52	254G3-2V52DL	66.04	63.50
12	254G3-2V12DL	15.24	12.70	54	254G3-2V54DL	68.58	66.04
14	254G3-2V14DL	17.78	15.24	56	254G3-2V56DL	71.12	68.58
16	254G3-2V16DL	20.32	17.78	58	254G3-2V58DL	73.66	71.12
18	254G3-2V18DL	22.86	20.32	60	254G3-2V60DL	76.20	73.66
20	254G3-2V20DL	25.40	22.86	62	254G3-2V62DL	78.74	76.20
22	254G3-2V22DL	27.94	25.40	64	254G3-2V64DL	81.28	78.74
24	254G3-2V24DL	30.48	27.94	66	254G3-2V66DL	83.82	81.28
26	254G3-2V26DL	33.02	30.48	68	254G3-2V68DL	86.36	83.82
28	254G3-2V28DL	35.56	33.02	70	254G3-2V70DL	88.90	86.36
30	254G3-2V30DL	38.10	35.56	72	254G3-2V72DL	91.44	88.90
32	254G3-2V32DL	40.64	38.10	74	254G3-2V74DL	93.98	91.44
34	254G3-2V34DL	43.18	40.64	76	254G3-2V76DL	96.52	93.98
36	254G3-2V36DL	45.72	43.18	78	254G3-2V78DL	99.06	96.52
38	254G3-2V38DL	48.26	45.72	80	254G3-2V80DL	101.60	99.06
40	254G3-2V40DL	50.80	48.26				
42	254G3-2V42DL	53.34	50.80				

Rev	Description/Date	Drawn By: Storm.li	Customer:	Third angle projection	Units: mm
△		Checked By:Simmon	Part No.: 254G3-2VXXDL		X.X X.XX X.XXX ±0.50 ±0.10 ±0.08
△		Approved By: Tony	Title: 2.54 mm Pin Header		
SGS Report No.:					

SOUTH SEA TERMINAL CO.,LTD