

| Rev | Revisions | Rev.Drawn | Date        |
|-----|-----------|-----------|-------------|
| A   |           | Du        | 22.May.2012 |

TABLE A

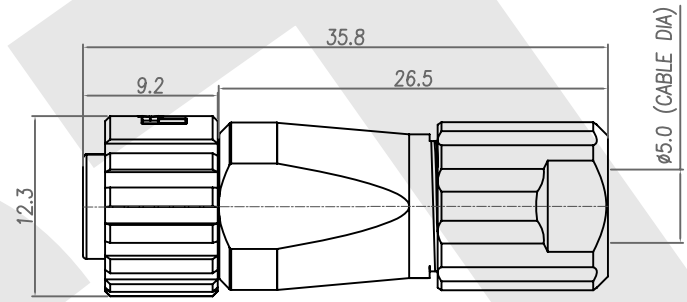
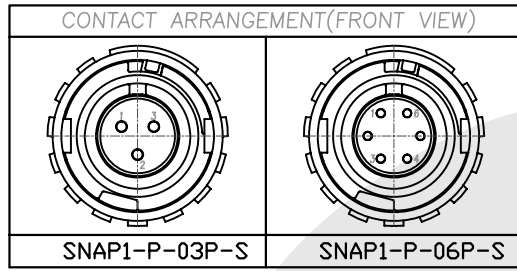

1. MATERIAL :

- 1-1. HOUSING : PPS UL94V-0  
COLOR : BLACK
- 1-2. CONTACT : BRASS
- 1-3. PLUG SHELL : ZINC ALLOY
- 1-4. LOCKING COLLAR : ZINC ALLOY
- 1-5. SPRING1 : STAINLESS STEEL
- 1-6. SPRING2 : STAINLESS STEEL
- 1-7. O-RING 1 : EPDM
- 1-8. BACK SHELL : ZINC ALLOY
- 1-9. SHIELDING : PHOSPHOR BRONZE
- 1-10. O-RING 2 : EPDM
- 1-11. CLAMP : BRASS
- 1-12. O-RING 3 : NBR ; COLOR : BLACK
- 1-13. STRAIN RELIEF COLLAR : NYLON66 UL94V-0 ; COLOR : WHITE
- 1-14. TIGHTENING COLLAR : PPS ; COLOR : BROWN

2. FINISH :

- 2-1. CONTACT : GOLD FLASH
- 2-2. PLUG SHELL : NICKEL
- 2-3. LOCKING COLLAR : NICKEL
- 2-4. BACK SHELL : NICKEL
- 2-5. SHIELDING : NICKEL
- 2-6. CLAMP : NICKEL

3. ORDERING INFORMATION : WATERPROOF SNAP CONNECTOR

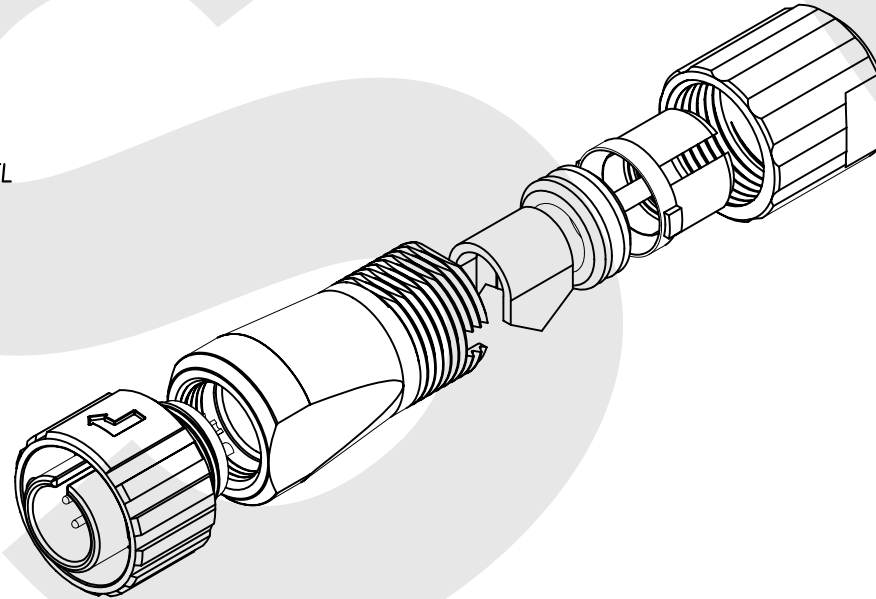
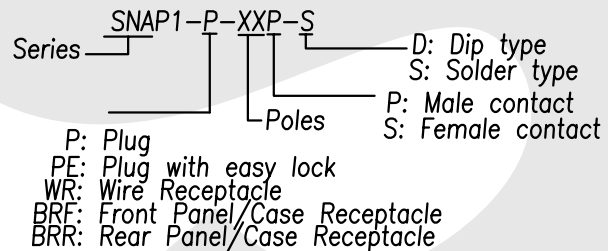

**SST SOUTH SEA TERMINAL CO.,LTD**

|   |                        |           |               |   |  |
|---|------------------------|-----------|---------------|---|--|
| SGS Report No.:                                   | Customer:              | Part No.: | SNAP1-P-XXP-S |   |  |
| Title: Waterproof Snap CONN. Plug Solder Type (M) |                        |           |               |   |  |
| Drawn By: Storm.Li                                | SCALE                  | SHEET     | REV.          | DWG NO.:  | TOLERANCE:   |
| Checked By: du                                    | 1:1                    | 1/2       | A             | QC5713  | .x ±0.20<br>.xx ±0.10<br>.xxx ±0.05<br>.xxxx ±0.03<br>ANGULA ±1° |
| Approved By: Tony                                 | Thire angle Projection |           |               | Units   | mm   |
| General Dimesion Tolerance                        |                        |           |               |  |  |

|     |           |           |             |
|-----|-----------|-----------|-------------|
| Rev | Revisions | Rev.Drawn | Date        |
| A   |           | Du        | 22.May.2012 |

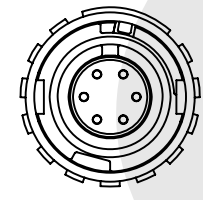
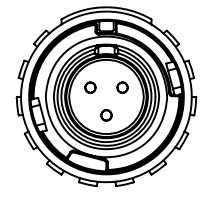
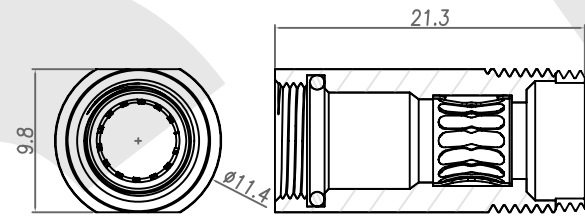
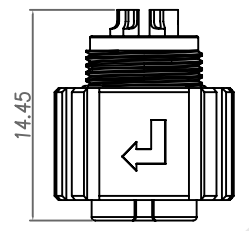
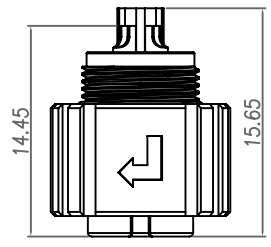

3P

6P

HOUSING+CONTACT+PLUG SHELL+SPRING1+SPRING2+O-RING1

BACK SHELL+SHIELDING+O-RING2

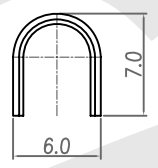
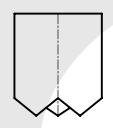

CRAMP

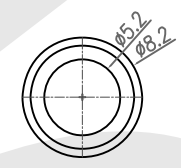

O-RING3

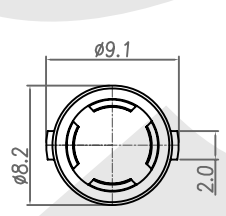
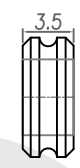

STRAIN RELIEF COLLAR

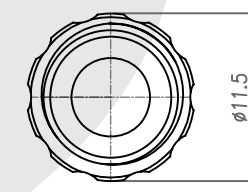
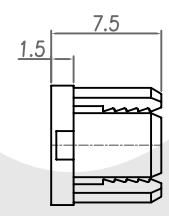

TIGHTENING COLLAR

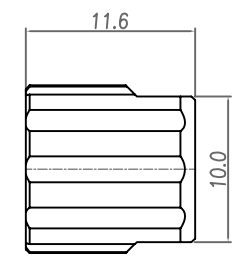

|   |                        |                         |                             |          |  |
|---|------------------------|-------------------------|-----------------------------|----------|--|
| <b>SST SOUTH SEA TERMINAL CO.,LTD</b>             |                        |                         |                             |          |  |
| SGS Report No.:                                   | Customer:              | Part No.: SNAP1-P-XXP-S |                             |          |  |
| Title: Waterproof Snap CONN. Plug Solder Type (M) |                        |                         |                             |          |  |
| Drawn By: Storm.Li                                | SCALE                  | SHEET                   | REV.                        | DWG NO.: | TOLERANCE:<br>.x ±0.20<br>.xx ±0.10<br>.xxx ±0.05<br>.xxxx ±0.03<br>ANGULA ±1° |
| Checked By: du                                    | 1:1                    | 2/2                     | A                           | QC5713   |  |
| Approved By: Tony                                 | Three angle Projection |                         | General Dimension Tolerance |          |  |